



KILLARK®

INSTALLATION, OPERATION & MAINTENANCE DATA SHEET

FORM NO. K1204, FOR EACH12, EACH16, & EZBA12 ADAPTERS.

For use in Class I, Division 1, Group D, Class II, Groups E, F, & G and Class III Hazardous Locations



FORM NO. K1204, FOR EACH12, EACH16, & EZBA12 ADAPTERS

CAUTION:

Before installing, make sure you are compliant with area classifications, failure to do so may result in bodily injury, death and property damage. Do not attempt installation until you are familiar with the following procedures. All installation must comply with the applicable Electrical Code.

Make sure that the circuit is de-energized before starting installation or maintenance.

Verify that the installation is grounded. Failure to ground will create electrical shock hazards, which can cause serious injury and or death.

IMPORTANT:

Please read these instructions carefully before installing or maintaining this equipment. Good electrical practices should be followed at all times and this data should be used as a guide only.

Technical information, advice and recommendations contained in these documents is based upon information that Killark believes to be reliable. All the information and advice contained in these documents is intended for use only by persons having been trained and possessing the requisite skill and know-how and to be used by such persons only at their own discretion and risk. The nature of these instructions is informative only and does not cover all of the details, variations or combinations in which this equipment may be used, its storage, delivery, installation, check out, safe operation and maintenance. Since conditions of use of the product are outside of the care, custody and control of Killark, the purchaser should determine the suitability of the product for his intended use, and assumes all risk and liability whatsoever in connection therewith.

KILLARK®



3940 Dr. Martin Luther King Drive
St. Louis, MO 63113

P/N KIL00921204 FORM NO. K1204 ECO-6-058-15 R11/2015

Page 1 of 5

NOTE: For Class I, Division 1 / Class II Hazardous Locations, use rigid conduit or appropriate cable connector.

NOTE: Pour les endroits dangereux Classe I, Division 1 / Classe II utiliser des conduits rigides.

NOTE: These adapters are for use with Crouse-Hinds mounts for use in Class I, Div. 1, Group D, Class II, Groups E, F, & G, and Class III Hazardous Locations. See the table below. Save this Instruction Sheet for maintenance and future reference.

Killark Cover Adapter Fitting	Cooper-Crouse Hinds Mounts	Killark Series Luminaire Fittings
EZBA-12	GUFX-26 Wall Mount	EZ, EMS, EBF-housing fittings
		With EZ Series: Cat. Nos. EZGS1 and EZGS2 With EMS Series: Cat. No. EMGS3 With EBF Series: Cat. No. EMGS1
		Guards (Optional)Globe Guard With EZ Series: Cat. Nos. EZG1 or VMAG-40 With EM Series: Cat. No. EMG2 With EBF Series: Cat. No. EMG1
		Reflectors (Optional) With EZ Series: Cat. Nos. VMPSD-40, VMPA-40 or HRD-400 With EM Series: Cat. Nos. ERS30 and ERA30 With EBF Series: Cat. Nos. ERS15 and ERA15
EACH-12	GUFX-26 Ceiling Mount	EZ, EMS, EBF-housing fittings
		Optics With EZ Series: Cat. Nos. EZGS1 and EZGS2 With EMS Series: Cat. No. EMGS3 With EBF Series: Cat. No. EMGS1
		Guards (Optional)Globe Guard With EZ Series: Cat. Nos. EZG1 or VMAG-40 With EMS Series: Cat. No. EMG2 With EBF Series: Cat. No. EMG1
		Reflectors (Optional) With EZ Series: Cat. Nos. VMPSD-40, VMPA-40 or HRD-400 With EMS Series: Cat. Nos. ERS30 and ERA30 With EBF Series: Cat. Nos. ERS15 and ERA15
EACH-16	EV-22 Ceiling Mount EV-87 Wall Mounting Module	EZ, EM, EBF-housing fittings
		Optics With EZ Series: Cat. Nos. EZGS1 and EZGS2 With EMS Series: Cat. No. EMGS3 With EBF Series: Cat. No. EMGS1
		Guards (Optional)Globe Guard With EZ Series: Cat. Nos. EZG1 or VMAG-40 With EMS Series: Cat. No. EMG2 With EBF Series: Cat. No. EMG1
		Reflectors (Optional) With EZ Series: Cat. Nos. VMPSD-40, VMPA-40 or HRD-400 With EMS Series: Cat. Nos. ERS30 and ERA30 With EBF Series: Cat. Nos. ERS15 and ERA15



1. INSTALLATION INSTRUCTIONS

A) EV-22 with Each 12 or GUFX-26 with EACH16 luminaire fittings: See Illustrations 1, 2, & 3:

1. Disassemble the luminaire from the mount by unscrewing the locking bolt between the cover and the luminaire body (Ill. 1).
2. Disconnect the power supply leads and remove the luminaire body.
3. Attach the appropriate adapter (EACH12 or EACH16) to the existing ceiling mount (Ill. 2). Be sure to tighten the locking screw/bolt between cover and adapter before going to next step.
4. Remove the terminal block from the adapter by loosening the 2 mounting screws. Connect the ground wire to the green screw in the adapter. Connect the supply wires to the terminal block (Ill. 3). Reinstall the terminal block and securely tighten it in place.
5. For installation of new luminaire housing, refer to separate instruction sheet supplied with the Killark , EZ, EMS or EBF series luminaires.

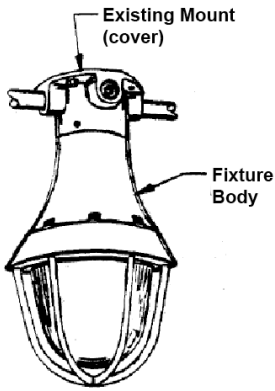

Ill. 1

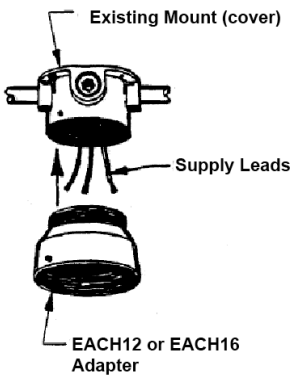

Ill. 2

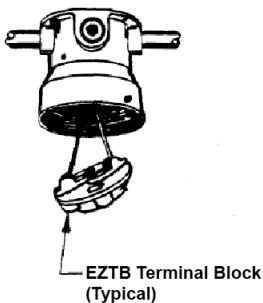

Ill. 3

**B) GUFX-26 Wall Mount Luminaire fittings
with EZBA12 Adapter:
See Illustrations 4, 5, & 6:**

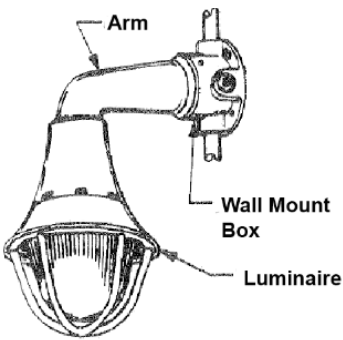

III. 4

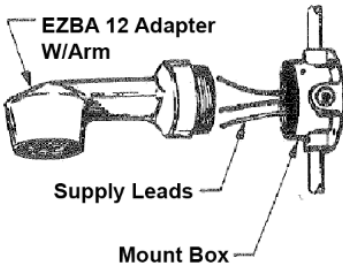

III. 5

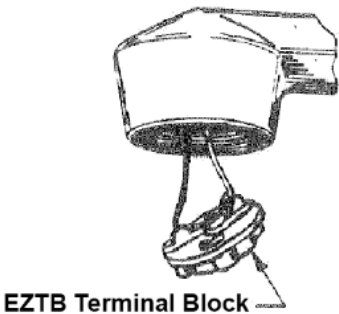

III. 6

1. Disassemble the luminaire from the mount by unscrewing the locking bolt between the wall mount box and the luminaire body (II. 4).
2. Disconnect the power supply leads and remove the luminaire body.
3. Attach the EZBA12 adapter assembly (III. 5). **NOTE:** Make sure the mount has the matching thread size and pitch.
4. Remove the terminal block from the adapter by loosening the 2 mounting screws. Connect the supply ground wire to the ground wire supplied with the adapter. Connect the supply leads to the terminal block. Reinstall the terminal block and tighten securely in place (III. 6).
5. For installation of new luminaire housing, refer to separate instruction sheet supplied with the Killark EZ, EMS, or EBF series luminaires.

**C) EV87 Wall Mount Luminaire Fittings
with EACH16 Adapter:
See Illustrations 7, 8, & 9:**

1. Disassemble the luminaire body. Disconnect power supply leads. (Ill. 7)
2. Attach EACH16 adapter (Ill. 8). Follow the instructions covered in Step 4 above (Ill. 9).
3. For installation of new luminaire housing, refer to separate instruction sheet supplied with the Killark EZ, EMS, or EBF series luminaires.

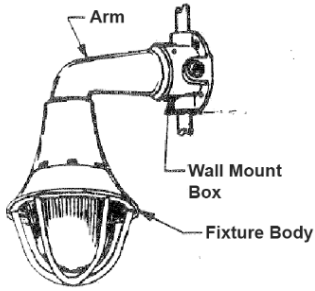

Ill. 7

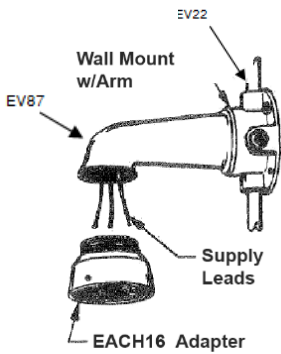

Ill. 8

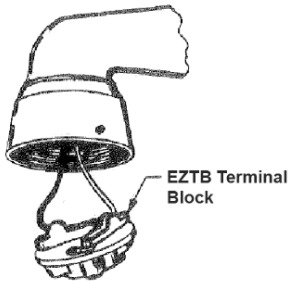

Ill. 9